

Cable Carrier T75.35 C/R

Produced in Nylon - Standard color: Black;
Temperature range: -30° ~120°C;

Opening system that facilitates changes and
maintenances of the cables and hoses.

Model with cables separator;

Model with reinforcing rivets.

*Recommended for hydraulic cables or for cable
carriers with more than 4 meters length.



Technical Specifications

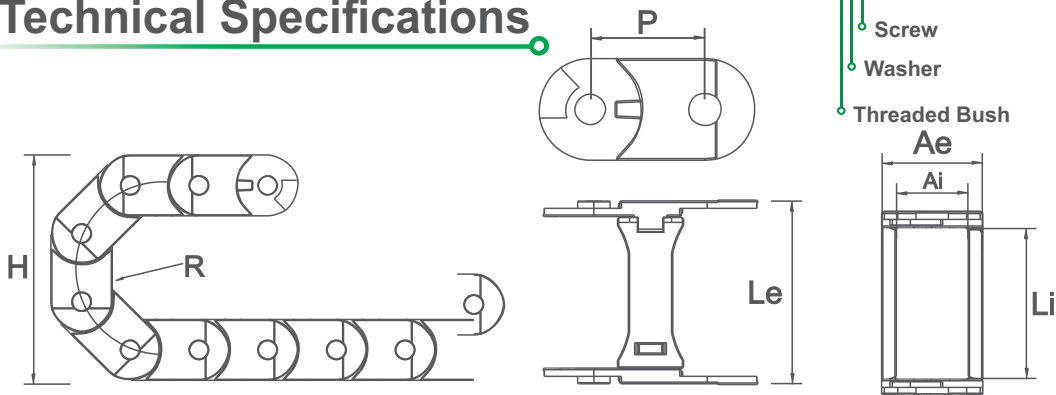

CODE	DESCRIPTION	INNER DIMENSIONS (Li x Ai)	EXTERNAL DIMENSIONS (Le x Ae)	HEIGHT (H)	RADIUS (R)	PITCH (P)	LINKS/ METRO	WEIGHT/ METRO
03640	CABLE CARRIER T75.35 R75mm With REINFORCEMENTS	75x35	102x50	185	75	56	18	1670gr
03773	CABLE CARRIER T75.35 R150mm With REINFORCEMENTS	75x35	102x50	335	150	56	18	1670gr

*Unit of measurement: millimeters

Cables Separator (Cód. 03558)

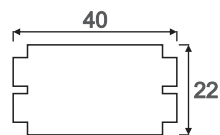

Example of separator
position inside of the link

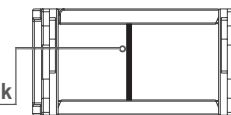

* Recommended to add
1 separator every 3 links

Mounting Brackets

Each cable carrier needs one set of mounting brackets made by two
brackets. Each bracket should be fixed in each end of the cable carrier.

CODE	DESCRIPTION	INNER DIMENSIONS (Li x Ai)	EXTERNAL DIMENSIONS (Le x Ae)
03485	MOUNTING BRACKETS SET T75.35	75x35	99x50

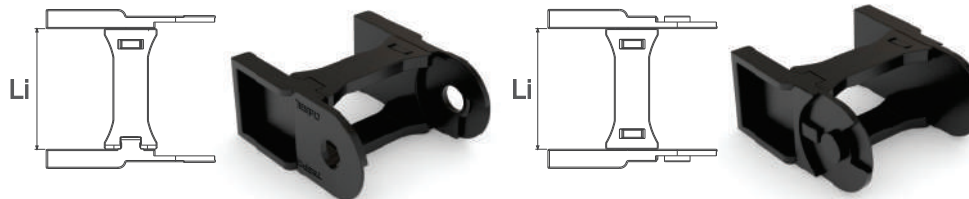

For fixing the mounting brackets, you
can add holes in the highlighted area.

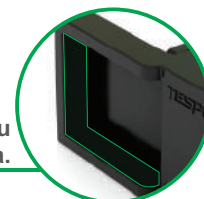

Assembly Plan

Step 1



Step 2



Step 3



Final Assembly

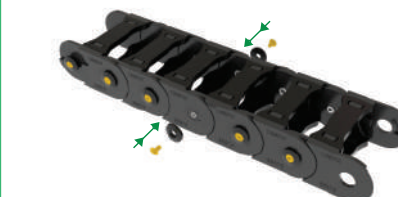

*Optional wrench is available to
help during assembly process
(Cód.03684)

